

Job:
Type:
Notes:



LED BOLLARD

Page 1 of 3

BRM830/831/833 Dome Top Louver BRM834/835/837 Bevel Top Louver

Featuring
Motion Response

Gardco's dome top and bevel top LED Louver Bollards provide uniform illumination, superior spacings and solid vandal resistance. Rugged extruded and cast construction with silicone seals and gasketing assure years of trouble free service. The BRM830 and BRM834 are complete assemblies with an aluminum base. BRM831 and BRM835 head only units affix to custom architectural elements. BRM833 and BRM837 luminaires include a concrete base assembly. Gardco's advanced stack-louver LED technology and Motion Response provide maximized light output and maximum energy savings.

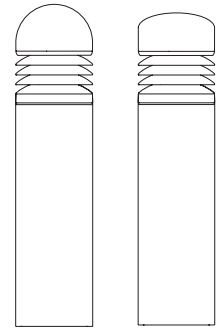

Dome Top Bevel Top



Enter the order code into the appropriate box above. Note: Gardco reserves the right to refuse a configuration. Not all combinations and configurations are valid. Refer to notes below for exclusions and limitations. For questions or concerns, please consult the factory.

PREFIX

| Dome Top | Bevel Top | | HEIGHT |
|---------------------|---------------------|----------------------------|---------|
| BRM830 | BRM834 | with Cast Aluminum Base | 42" 36" |
| BRM831 ¹ | BRM835 ¹ | Head Only | 11" |
| BRM833 | BRM837 | with Natural Concrete Base | 42" |
| BRM833B | BRM837B | with Beige Concrete Base | 42" |
| BRM833G | BRM837G | with Grey Concrete Base | 42" |

1. Not Available in 347V.

LED CONTROL

MR Motion Response
LEDs stay on Low Level (8 watts) when no motion is present. LEDs increase to full light output (41 watts) when motion detected.

CWL Constant Wattage Full Light Output
Full light output only (41 watts). No motion sensor included.

(Note: A variation of LED wattage (+/- 8%) may occur due to LED manufacturer's forward volt specification and ambient temperature.)

LED SELECTION

| | |
|-----------|----------------|
| CW | 6,500°K, 75CRI |
| NW | 4,300°K, 75CRI |
| WW | 3,000°K, 75CRI |

Solid Colors

| | |
|-----------|-------|
| LA | Amber |
| LR | Red |
| LG | Green |
| LB | Blue |

Consult factory for lead times on LEDs other than CW, NW, and WW.

LIGHTED COVERAGE

| | |
|------------|--|
| 360 | 360° lighted louvers |
| 180 | 180° lighted louvers (Provides reduced backside light.) |

VOLTAGE

| | |
|------------------------|---|
| UNIV | 120V through 277V, 50hz to 60hz input. |
| 347² | 347V |

Voltage Note:

2. 347V bollards require and include a step-down transformer in bollard. Not available in BRM831 or BRM835.

FINISH

| | | | |
|------------|------------------------|-----------|--|
| BRP | Bronze Paint | OC | Optional Color Paint Specify RAL designation as ex: OC-RAL7024. |
| BLP | Black Paint | | |
| WP | White Paint | | |
| NP | Natural Aluminum Paint | | |
| BGP | Beige Paint | SC | Special Color Paint Specify. Must supply color chip. |
| VP | Verde Green Paint | | |
| LGP | Light Granite Paint | | |
| DGP | Dark Granite Paint | | |
| LSP | Light Sandstone Paint | | |
| DSP | Dark Sandstone Paint | | |
| RBP | Red Brick Paint | | |

OPTIONS

| | |
|-------------|--|
| SPR | Surge Protection for 120V through 277V Input meeting ANSI C62.41.2 |
| SPRH | Surge Protection for 347V through 480V Input meeting ANSI C62.41.2 |

1611 Clovis Barker Road, San Marcos, TX 78666

(800) 227-0758 (512) 753-1000 FAX: (512) 753-7855 sitelighting.com

© 2012 Koninklijke Philips Electronics N.V. All Rights Reserved.

Philips Gardco reserves the right to change materials or modify the design of its product without notification as part of the company's continuing product improvement program.

G200-009/1012

PHILIPS





LED BOLLARD

BRM830/831/833 Dome Top Louver
BRM834/835/837 Bevel Top Louver

Featuring
Motion Response

DIMENSIONS

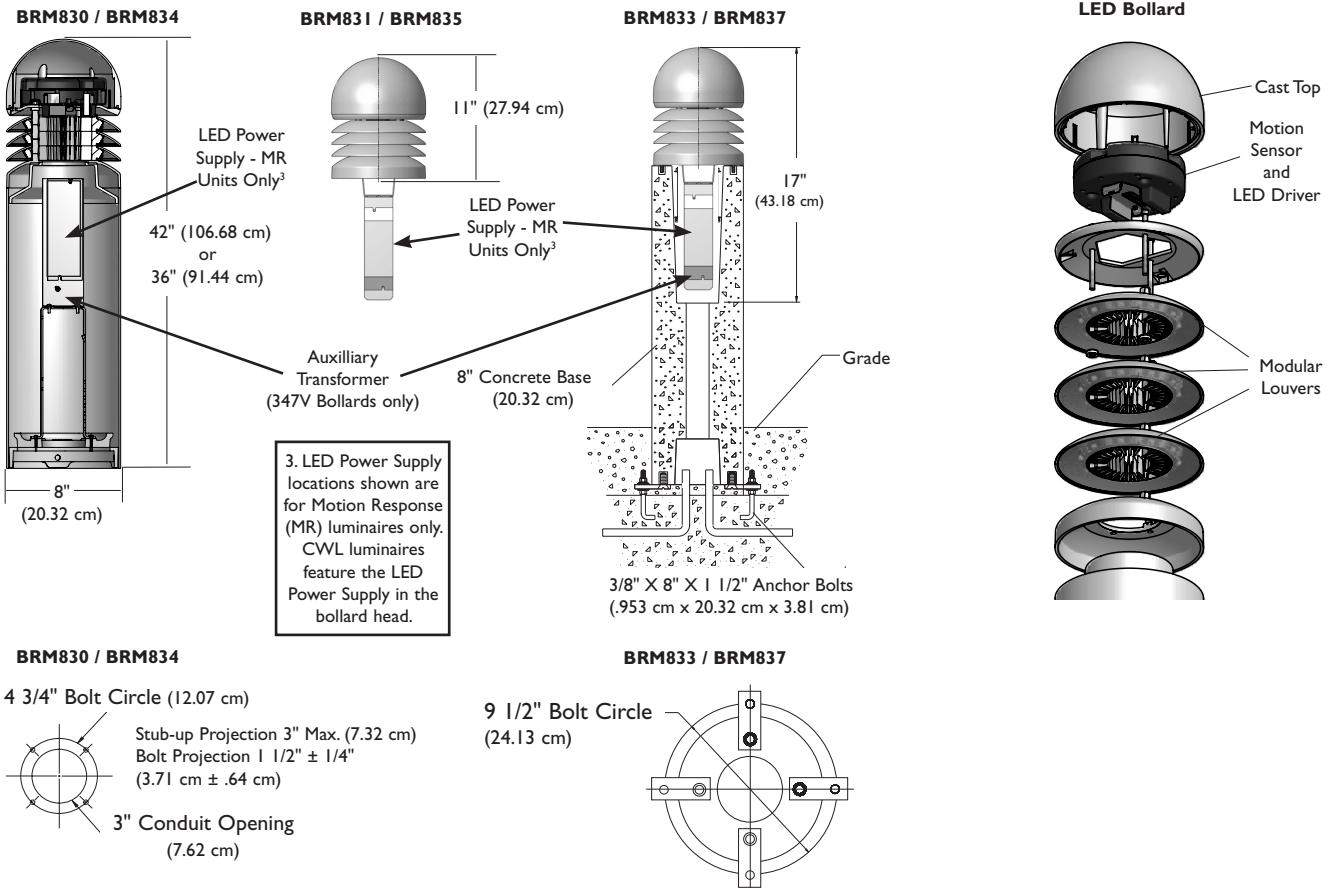

NOTE: Factory supplied template must be used when setting anchor bolts. Philips Gardco will not honor any claim for incorrect anchorage placement from failure to use factory supplied templates.



LED BOLLARD

Page 3 of 3

BRM830/831/833 Dome Top Louver
BRM834/835/837 Bevel Top Louver

Featuring
Motion Response

SPECIFICATIONS

UPPER HOUSING: Diecast aluminum dome top secures to one-piece louvered casting with three (3) concealed tamper resistant screws.

LOWER HOUSING:

BRM830 / BRM834 : Luminaire features a cylindrical .125" (.318 cm) wall 6063-T5 extruded aluminum base housing. Bottom section has a welded-in cast ring for attachment to base assembly with four (4) hex head set screws.

BRM831 / BRM835 : Louver head assembly is affixed to ballast mounting bracket which is suitable for insertion into architectural elements (by others).

BRM 833 / BRM837: Luminaire includes a pre-cast concrete base constructed with steel molds and wire reinforcing. Base is acid-etched to provide a smooth textured aggregate finish.

LED PERFORMANCE:

| PREDICTED LUMEN DEPRECIATION DATA ⁴ | | |
|--|-----------|------------------------------------|
| Ambient Temperature °C | Driver mA | L ₇₀ Hours ⁵ |
| 15 °C | 350 | 112,000 |
| 25 °C | 350 | 90,000 |
| 40 °C | 350 | 65,000 |

4. Predicted performance derived from LED manufacturer's data and engineering design estimates, based on IESNA LM-80 methodology. Actual experience may vary due to field application conditions.
5. L₇₀ is the predicted time when LED performance depreciates to 70% of initial lumen output.

OPTICAL SYSTEM: Gardco LED Bollards feature the advanced Gardco stacked louver LED technology, assuring maximized light output. Each individual louver is replaceable if needed or desired.

ANCHORAGE:

BRM830 / BRM834: Base assembly consists of a cast aluminum platform and ballast mounting bracket. Assembly is secured and leveled to the mounting foundation with four (4) 3/8" X 8" x 1 1/2" (.953 cm x 20.32 cm x 3.81 cm) anchor bolts on a 4 3/4" (12.07 cm) bolt circle.

BRM 831 / BRM835: Mounting plate is cast aluminum with slots to accept anchor bolts (by others) at 90° on a 6 1/4" (15.88 cm) diameter bolt circle. A 4 1/2" (11.43 cm) diameter opening is required to house LED Power Supply for Motion Response (MR) units.

BRM833 / BRM837: Base assembly consists of four (4) galvanized steel base tabs fastened to pre-cast concrete base. Assembly is secured and leveled to the mounting foundation with four (4) 3/8" X 8" X 1 1/2" (.953 cm x 20.32 cm x 3.81 cm) anchor bolts on a 9 1/2" (24.13 cm) bolt circle. Base is designed for 5" (12.7 cm) direct burial.

ELECTRICAL: For CWL bollards, the LED power supply is located within the bollard head. For Motion Response (MR) bollards the LED power supply is located within the bollard shaft. Bollards accept from 120 Volts through 277 Volts, 50hz to 60 hz, input. Bollards with 347V input require and include a step-down transformer (placed within the bollard shaft) to provide proper input voltage to the LED power supply. The LED driver is located in the upper dome. LED power supplies and LED drivers are replaceable. LEDs provided as specified.

Luminaires ordered with Motion Response include a microwave motion sensor. The motion sensor is completely and safely concealed within the LED Bollard head to avoid potential vandalism to the sensor. LEDs operate on Low Level (8 watts) when no motion is present. LEDs increase to full light output (41 watts) when motion is detected. Motion Response system permits adjustments for time on high level and motion sensitivity.

Approximate Motion Sensor Detection Pattern:

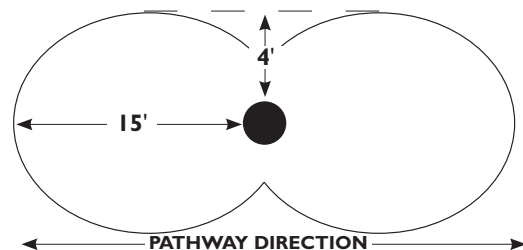

Bollard orientation is adjustable in 120° increments. Consult LED Bollard Motion Response installation instruction sheets for more detailed information concerning bollard placement and sensor performance.

LUMINAIRE FINISH: Each luminaire receives a fade and abrasion resistant, electrostatically applied, thermally cured textured powdercoat finish

LABELS: All luminaires bear UL or CUL (where applicable) Wet Location labels.

WARRANTY: Gardco luminaires feature a 5 year limited warranty. Gardco LED luminaires with LED arrays or modules feature a 5 year limited warranty covering the LED arrays or modules. See Warranty Information on www.sitelighting.com for complete details and exclusions.

1611 Clovis Barker Road, San Marcos, TX 78666

(800) 227-0758 (512) 753-1000 FAX: (512) 753-7855 [sitelighting.com](http://www.sitelighting.com)

© 2012 Koninklijke Philips Electronics N.V. All Rights Reserved.

Philips Gardco reserves the right to change materials or modify the design of its product without notification as part of the company's continuing product improvement program.

G200-009/1012

PHILIPS

GARDCO

Westbrooke LEDGINE (CXF14) Specification Sheet

| | | |
|---------------|--------------|--------------------|
| Project Name: | Location: | MFG: Philips Hadco |
| Fixture Type: | Catalog No.: | Qty: |

Ordering Guide

Example: CXF14 32 A 2 N A 3 N S F

| Product Code | CXF14 | Westbrooke LEDGINE |
|--------------------------|-------------------------|------------------------|
| LED BOARDS | 32 | 32 LED'S |
| | 48 | 48 LED'S |
| | 64 | 64 LED'S |
| | 80 | 80 LED'S |
| Finish | A | Black |
| | B | White |
| | G | Verde |
| | H | Bronze |
| | I | Gray |
| | J | Green |
| Optics | 2 | Type II |
| | 3 | Type III |
| | 4 | Type IV |
| | 5 | Type V |
| Color Temperature | N | 4000K |
| Voltage | A | 120-277 VAC |
| | B | 347-480 VAC |
| Drive Current | 3 | 350 mA |
| Dimming Control | N | None |
| | DA | 4 Hrs 25% Reduction |
| | DB | 4 Hrs 50% Reduction |
| | DC | 4 Hrs 75% Reduction |
| | DD | 6 Hrs 25% Reduction |
| | DE | 6 Hrs 50% Reduction |
| | DF | 6 Hrs 75% Reduction |
| | DG | 8 Hrs 25% Reduction |
| | DH | 8 Hrs 50% Reduction |
| | DJ | 8 Hrs 75% Reduction |
| DZ | Custom Dimming Schedule | |
| Surge Suppression | S | Standard Built In <3kV |
| | A | Additional 10kV/10kA |
| Options | F | Fluted Spinning |
| | N | None |

*1 Can not use B Voltage (347-480VAC) and can not use Dimming (DA-DZ) options with the 32LED board option.

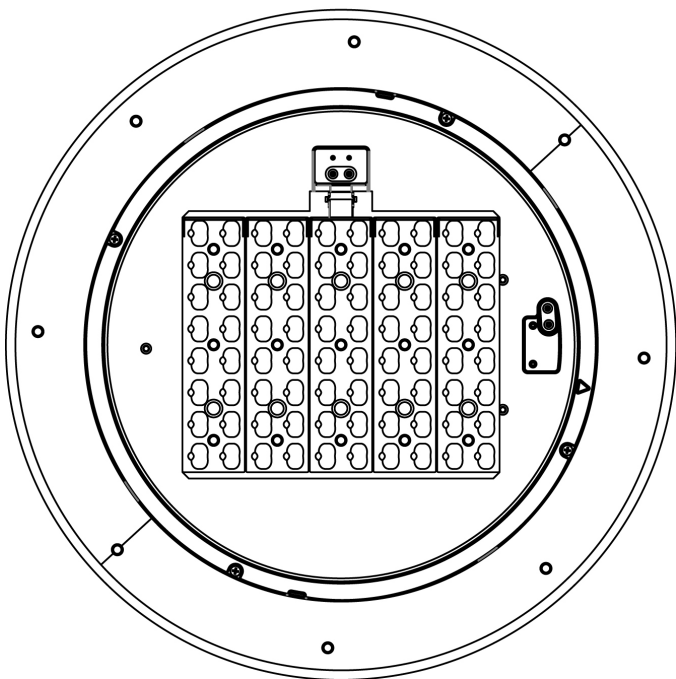
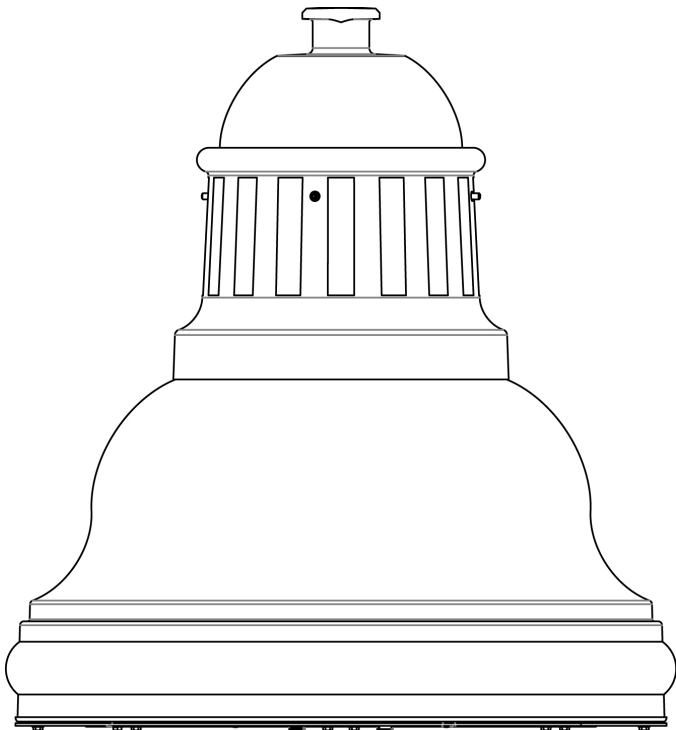

**AFCU Cedar Hills
TYPE 'P1' (20' height w/ 5' arm)
#CXF14 80 A 4 N A 3 N S N**

Westbrooke LEDGINE (CXF14) Specification Sheet

| | | |
|---------------|--------------|--------------------|
| Project Name: | Location: | MFG: Philips Hadco |
| Fixture Type: | Catalog No.: | Qty: |

Specifications

APPLICATIONS:

The CXF14 is the perfect LED solution for decorative street lighting and is the ideal luminaire for both new and retrofit installations. Other application locations include: residential streets, city streets, campuses and parking lots. The performance, energy savings, and uniformity of this luminaire make it an ideal pendant LED solution.

CONSTRUCTION:

Containing no mercury or other hazardous chemicals, the CXF14 is fully recyclable. The housing is constructed of low copper die-cast aluminum and 0.090" thick spun aluminum. The hinged lens frame is cast aluminum with a stainless steel spring latch for tool-less lamp access. All non-ferrous fasteners prevent corrosion and ensure longer life. Mounting options include side arm, top arm and wall mount.

LED SPECIFICATIONS:

Refer to IES files for energy consumption and delivered lumens for each option. Based on in-situ thermal testing and data from Philips Lumileds and Philips Advance, fixture can be expected to reach 65,000 hours (at >L70 lumen maintenance @ 25°C). The Philips LEDGINE uses Philips Lumileds LEDs. Color temperatures available are ANSI Bin 4000KCCT. Four distributions are available including Type 2, 3, 4 and 5.

ELECTRONIC DRIVER:

The driver included in the LEDGINE Pendants is the Philips Advance XITANIUM LED driver. Standard driver offers 0-10V dimming capability and universal voltage input from 120-277VAC or 347-480VAC. 40 LED options are not available with 0-10V dimming or 347-480V. Input frequency is 50-60Hz and all XITANIUM drivers are RoHS compliant. The driver has <3kV surge suppression built in, 10kV is an additional option.

FINISH:

Thermoset polyester powdercoat is electrostatically applied after a five-stage conversion cleaning process and bonded by heat fusion thermosetting. Laboratory tested for superior weatherability and fade resistance in accordance with ASTM B117 specifications. Powdercoat is 3.0 - 6.0 mil thickness. Interior Coating: approximately 2 ft. at base end of shaft is mechanically cleaned and coated with a zinc rich epoxy powder.

CONTROLS:

The Philips Dynadimmer is an option with this fixture. There are 9 standard factory set dimming schedules available. See specification sheet for details. A custom dimming schedule is available by contacting the factory. Wireless dimming options are also available, contact the factory for details.

IP RATING:

IP66: Dust-tight and sealed against direct jets of water. No Ingress of dust. Will withstand 26.4 gallons of water per minute. Water projected in powerful jets shall not enter the enclosure in harmful quantities. The LED optics chamber is IP66 rated.

CERTIFICATIONS:

ETL listed to U.S. safety standards for wet locations. cETL listed to Canadian safety standards for wet locations. UL8750 and UL1598 compliant. Vibration tested to ANSI C136.31 for Normal Applications. Manufactured to ISO 9001:2008 Standards.

WARRANTY:

5 year extended warranty

OPTIONS:

Optional integral surge suppression device tested in accordance with ANSI/IEEE C62.45 per ANSI/IEEE C62.41.2 Scenario I Category C High Exposure 10kV/10kA waveforms for Line-Ground, Line-Neutral and Neutral-Ground. Enclosure for surge suppression device is constructed of high temperature, flameproof material with an 85°C maximum surface temperature rating. The device consists of a thermally protected transient overvoltage circuit and is designed for use with universal voltage ballasts and drivers.

Width:

21" (diameter)

Height :

22 5/16"

EPA:

1.6 sq ft

Max. Weight:

38 lbs

Westbrooke LEDGINE (CXF14) Specification Sheet

| | | |
|---------------|--------------|--------------------|
| Project Name: | Location: | MFG: Philips Hadco |
| Fixture Type: | Catalog No.: | Qty: |

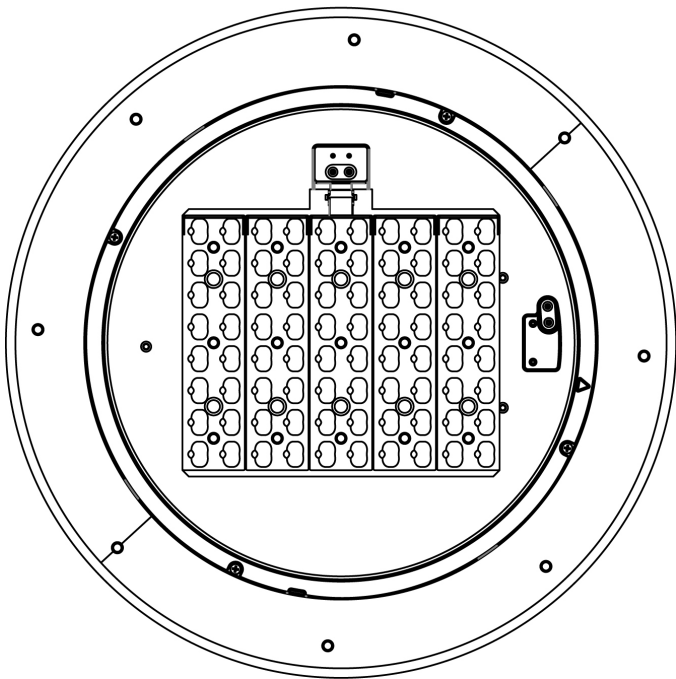
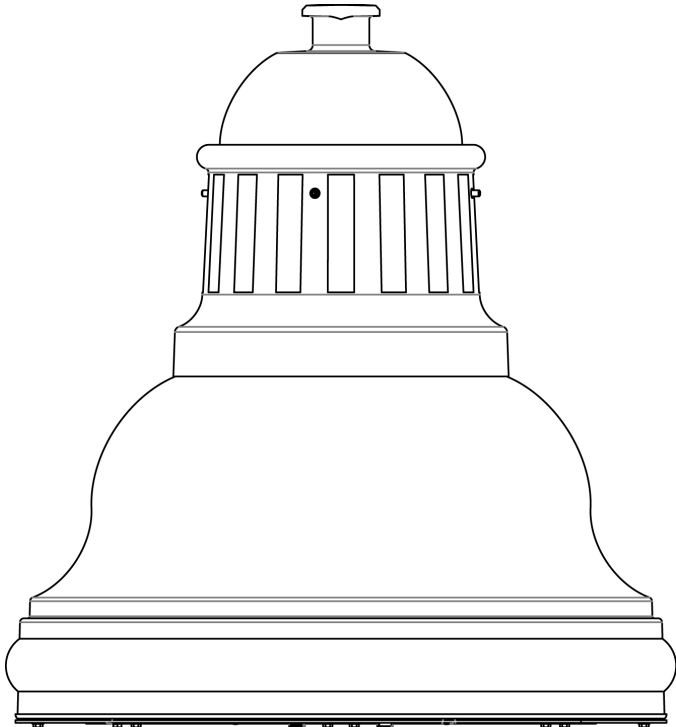

Ordering Guide

Example: CXF14 32 A 2 N A 3 N S F

| Product Code | CXF14 | Westbrooke LEDGINE |
|--------------------------|---|--|
| LED BOARDS | 32 48 64 80 | 32 LED'S 48 LED'S 64 LED'S 80 LED'S |
| Finish | A B G H I J | Black White Verde Bronze Gray Green |
| Optics | 2 3 4 5 | Type II Type III Type IV Type V |
| Color Temperature | N | 4000K |
| Voltage | A B | 120-277 VAC 347-480 VAC |
| Drive Current | 3 | 350 mA |
| Dimming Control | N DA DB DC DD DE DF DG DH DJ DZ | None 4 Hrs 25% Reduction 4 Hrs 50% Reduction 4 Hrs 75% Reduction 6 Hrs 25% Reduction 6 Hrs 50% Reduction 6 Hrs 75% Reduction 8 Hrs 25% Reduction 8 Hrs 50% Reduction 8 Hrs 75% Reduction Custom Dimming Schedule |
| Surge Suppression | S A | Standard Built In <3kV Additional 10kV/10kA |
| Options | F N | Fluted Spinning None |

*1 Can not use B Voltage (347-480VAC) and can not use Dimming (DA-DZ) options with the 32LED board option.

**AFCU Cedar Hills
TYPE 'P2' (20' height w/ 5' arm)
#CXF14 80 A 3 N A 3 N S N**

Westbrooke LEDGINE (CXF14) Specification Sheet

| | | |
|---------------|--------------|--------------------|
| Project Name: | Location: | MFG: Philips Hadco |
| Fixture Type: | Catalog No.: | Qty: |

Specifications

APPLICATIONS:

The CXF14 is the perfect LED solution for decorative street lighting and is the ideal luminaire for both new and retrofit installations. Other application locations include: residential streets, city streets, campuses and parking lots. The performance, energy savings, and uniformity of this luminaire make it an ideal pendant LED solution.

CONSTRUCTION:

Containing no mercury or other hazardous chemicals, the CXF14 is fully recyclable. The housing is constructed of low copper die-cast aluminum and 0.090" thick spun aluminum. The hinged lens frame is cast aluminum with a stainless steel spring latch for tool-less lamp access. All non-ferrous fasteners prevent corrosion and ensure longer life. Mounting options include side arm, top arm and wall mount.

LED SPECIFICATIONS:

Refer to IES files for energy consumption and delivered lumens for each option. Based on in-situ thermal testing and data from Philips Lumileds and Philips Advance, fixture can be expected to reach 65,000 hours (at >L70 lumen maintenance @ 25°C). The Philips LEDGINE uses Philips Lumileds LEDs. Color temperatures available are ANSI Bin 4000KCCT. Four distributions are available including Type 2, 3, 4 and 5.

ELECTRONIC DRIVER:

The driver included in the LEDGINE Pendants is the Philips Advance XITANIUM LED driver. Standard driver offers 0-10V dimming capability and universal voltage input from 120-277VAC or 347-480VAC. 40 LED options are not available with 0-10V dimming or 347-480V. Input frequency is 50-60Hz and all XITANIUM drivers are RoHS compliant. The driver has <3kV surge suppression built in, 10kV is an additional option.

FINISH:

Thermoset polyester powdercoat is electrostatically applied after a five-stage conversion cleaning process and bonded by heat fusion thermosetting. Laboratory tested for superior weatherability and fade resistance in accordance with ASTM B117 specifications. Powdercoat is 3.0 - 6.0 mil thickness. Interior Coating: approximately 2 ft. at base end of shaft is mechanically cleaned and coated with a zinc rich epoxy powder.

CONTROLS:

The Philips Dynadimmer is an option with this fixture. There are 9 standard factory set dimming schedules available. See specification sheet for details. A custom dimming schedule is available by contacting the factory. Wireless dimming options are also available, contact the factory for details.

IP RATING:

IP66: Dust-tight and sealed against direct jets of water. No Ingress of dust. Will withstand 26.4 gallons of water per minute. Water projected in powerful jets shall not enter the enclosure in harmful quantities. The LED optics chamber is IP66 rated.

CERTIFICATIONS:

ETL listed to U.S. safety standards for wet locations. cETL listed to Canadian safety standards for wet locations. UL8750 and UL1598 compliant. Vibration tested to ANSI C136.31 for Normal Applications. Manufactured to ISO 9001:2008 Standards.

WARRANTY:

5 year extended warranty

OPTIONS:

Optional integral surge suppression device tested in accordance with ANSI/IEEE C62.45 per ANSI/IEEE C62.41.2 Scenario I Category C High Exposure 10kV/10kA waveforms for Line-Ground, Line-Neutral and Neutral-Ground. Enclosure for surge suppression device is constructed of high temperature, flameproof material with an 85°C maximum surface temperature rating. The device consists of a thermally protected transient overvoltage circuit and is designed for use with universal voltage ballasts and drivers.

Width:

21" (diameter)

Height :

22 5/16"

EPA:

1.6 sq ft

Max. Weight:

38 lbs

Westbrooke LEDGINE (CXF14) Specification Sheet

| | | |
|---------------|--------------|--------------------|
| Project Name: | Location: | MFG: Philips Hadco |
| Fixture Type: | Catalog No.: | Qty: |

Ordering Guide

Example: CXF14 32 A 2 N A 3 N S F

| Product Code | CXF14 | Westbrooke LEDGINE |
|--------------------------|-------------------------|------------------------|
| LED BOARDS | 32 | 32 LED'S |
| | 48 | 48 LED'S |
| | 64 | 64 LED'S |
| | 80 | 80 LED'S |
| Finish | A | Black |
| | B | White |
| | G | Verde |
| | H | Bronze |
| | I | Gray |
| | J | Green |
| Optics | 2 | Type II |
| | 3 | Type III |
| | 4 | Type IV |
| | 5 | Type V |
| Color Temperature | N | 4000K |
| Voltage | A | 120-277 VAC |
| | B | 347-480 VAC |
| Drive Current | 3 | 350 mA |
| Dimming Control | N | None |
| | DA | 4 Hrs 25% Reduction |
| | DB | 4 Hrs 50% Reduction |
| | DC | 4 Hrs 75% Reduction |
| | DD | 6 Hrs 25% Reduction |
| | DE | 6 Hrs 50% Reduction |
| | DF | 6 Hrs 75% Reduction |
| | DG | 8 Hrs 25% Reduction |
| | DH | 8 Hrs 50% Reduction |
| | DJ | 8 Hrs 75% Reduction |
| DZ | Custom Dimming Schedule | |
| Surge Suppression | S | Standard Built In <3kV |
| | A | Additional 10kV/10kA |
| Options | F | Fluted Spinning |
| | N | None |

*1 Can not use B Voltage (347-480VAC) and can not use Dimming (DA-DZ) options with the 32LED board option.

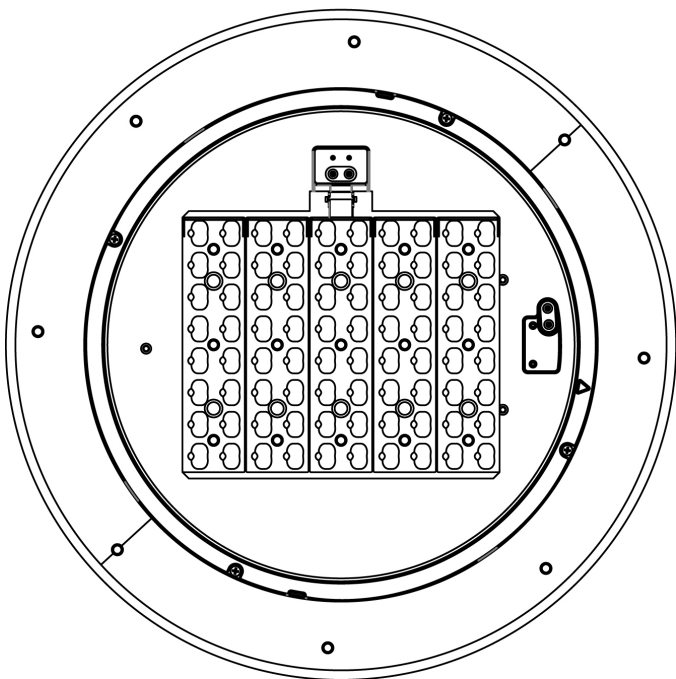
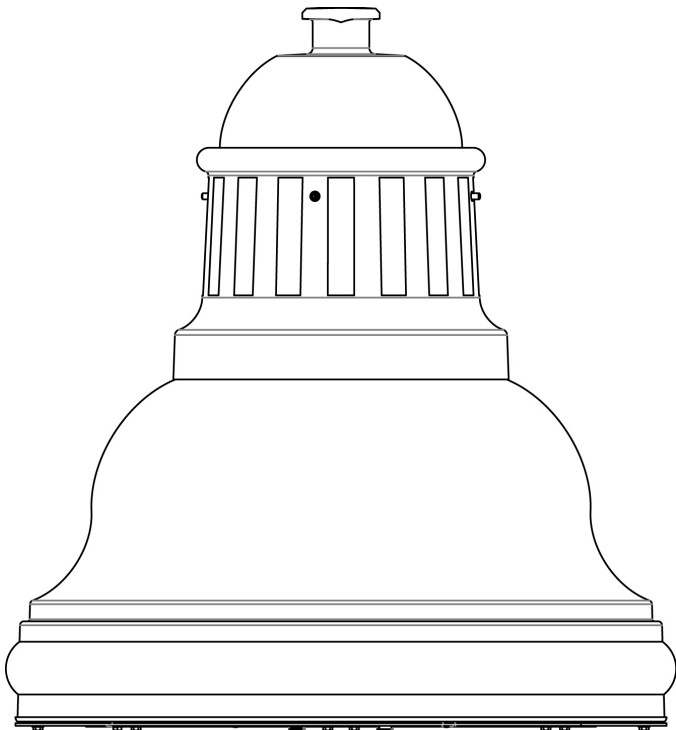

AFCU Cedar Hills
 TYPE 'P4' TWO HEADS
 (20' height w/ 5' arm)
 #CXF14 80 A 3 N A 3 N S N
 #CXF14 80 A 4 N A 3 N S N

Westbrooke LEDGINE (CXF14) Specification Sheet

| | | |
|---------------|--------------|--------------------|
| Project Name: | Location: | MFG: Philips Hadco |
| Fixture Type: | Catalog No.: | Qty: |

Specifications

APPLICATIONS:

The CXF14 is the perfect LED solution for decorative street lighting and is the ideal luminaire for both new and retrofit installations. Other application locations include: residential streets, city streets, campuses and parking lots. The performance, energy savings, and uniformity of this luminaire make it an ideal pendant LED solution.

CONSTRUCTION:

Containing no mercury or other hazardous chemicals, the CXF14 is fully recyclable. The housing is constructed of low copper die-cast aluminum and 0.090" thick spun aluminum. The hinged lens frame is cast aluminum with a stainless steel spring latch for tool-less lamp access. All non-ferrous fasteners prevent corrosion and ensure longer life. Mounting options include side arm, top arm and wall mount.

LED SPECIFICATIONS:

Refer to IES files for energy consumption and delivered lumens for each option. Based on in-situ thermal testing and data from Philips Lumileds and Philips Advance, fixture can be expected to reach 65,000 hours (at >L70 lumen maintenance @ 25°C). The Philips LEDGINE uses Philips Lumileds LEDs. Color temperatures available are ANSI Bin 4000KCCT. Four distributions are available including Type 2, 3, 4 and 5.

ELECTRONIC DRIVER:

The driver included in the LEDGINE Pendants is the Philips Advance XITANIUM LED driver. Standard driver offers 0-10V dimming capability and universal voltage input from 120-277VAC or 347-480VAC. 40 LED options are not available with 0-10V dimming or 347-480V. Input frequency is 50-60Hz and all XITANIUM drivers are RoHS compliant. The driver has <3kV surge suppression built in, 10kV is an additional option.

FINISH:

Thermoset polyester powdercoat is electrostatically applied after a five-stage conversion cleaning process and bonded by heat fusion thermosetting. Laboratory tested for superior weatherability and fade resistance in accordance with ASTM B117 specifications. Powdercoat is 3.0 - 6.0 mil thickness. Interior Coating: approximately 2 ft. at base end of shaft is mechanically cleaned and coated with a zinc rich epoxy powder.

CONTROLS:

The Philips Dynadimmer is an option with this fixture. There are 9 standard factory set dimming schedules available. See specification sheet for details. A custom dimming schedule is available by contacting the factory. Wireless dimming options are also available, contact the factory for details.

IP RATING:

IP66: Dust-tight and sealed against direct jets of water. No Ingress of dust. Will withstand 26.4 gallons of water per minute. Water projected in powerful jets shall not enter the enclosure in harmful quantities. The LED optics chamber is IP66 rated.

CERTIFICATIONS:

ETL listed to U.S. safety standards for wet locations. cETL listed to Canadian safety standards for wet locations. UL8750 and UL1598 compliant. Vibration tested to ANSI C136.31 for Normal Applications. Manufactured to ISO 9001:2008 Standards.

WARRANTY:

5 year extended warranty

OPTIONS:

Optional integral surge suppression device tested in accordance with ANSI/IEEE C62.45 per ANSI/IEEE C62.41.2 Scenario I Category C High Exposure 10kV/10kA waveforms for Line-Ground, Line-Neutral and Neutral-Ground. Enclosure for surge suppression device is constructed of high temperature, flameproof material with an 85°C maximum surface temperature rating. The device consists of a thermally protected transient overvoltage circuit and is designed for use with universal voltage ballasts and drivers.

Width:

21" (diameter)

Height :

22 5/16"

EPA:

1.6 sq ft

Max. Weight:

38 lbs

Westbrooke LEDGINE (CXF14) Specification Sheet

| | | |
|---------------|--------------|--------------------|
| Project Name: | Location: | MFG: Philips Hadco |
| Fixture Type: | Catalog No.: | Qty: |

Ordering Guide

Example: CXF14 32 A 2 N A 3 N S F

| Product Code | CXF14 | Westbrooke LEDGINE |
|--------------------------|-------|-------------------------|
| LED BOARDS | 32 | 32 LED'S |
| | 48 | 48 LED'S |
| | 64 | 64 LED'S |
| | 80 | 80 LED'S |
| | | |
| Finish | A | Black |
| | B | White |
| | G | Verde |
| | H | Bronze |
| | I | Gray |
| | J | Green |
| Optics | 2 | Type II |
| | 3 | Type III |
| | 4 | Type IV |
| | 5 | Type V |
| | | |
| Color Temperature | N | 4000K |
| Voltage | A | 120-277 VAC |
| | B | 347-480 VAC |
| Drive Current | 3 | 350 mA |
| Dimming Control | N | None |
| | DA | 4 Hrs 25% Reduction |
| | DB | 4 Hrs 50% Reduction |
| | DC | 4 Hrs 75% Reduction |
| | DD | 6 Hrs 25% Reduction |
| | DE | 6 Hrs 50% Reduction |
| | DF | 6 Hrs 75% Reduction |
| | DG | 8 Hrs 25% Reduction |
| | DH | 8 Hrs 50% Reduction |
| | DJ | 8 Hrs 75% Reduction |
| | DZ | Custom Dimming Schedule |
| Surge Suppression | S | Standard Built In <3kV |
| | A | Additional 10kV/10kA |
| Options | F | Fluted Spinning |
| | N | None |

*1 Can not use B Voltage (347-480VAC) and can not use Dimming (DA-DZ) options with the 32LED board option.

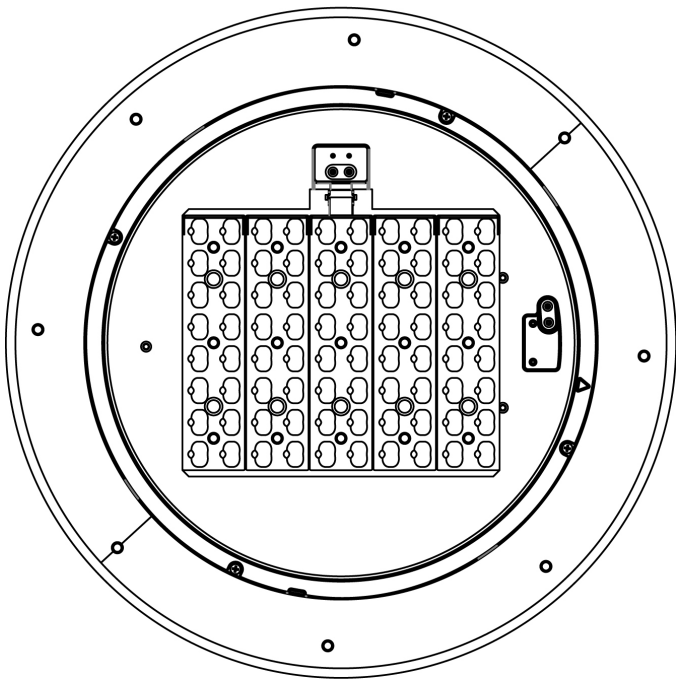
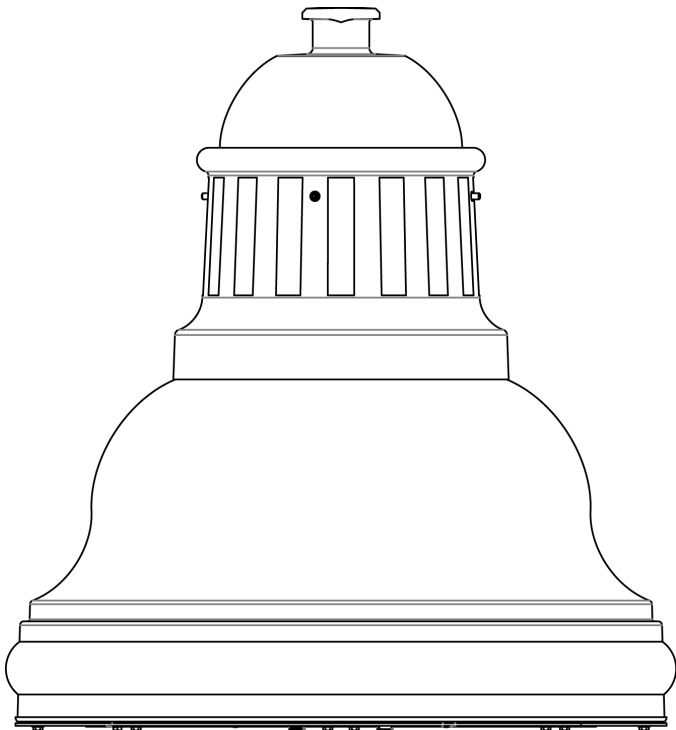

AFCU CEDAR HILLS
TYPE 'P5' (12' height w/ 2' arm)
#CXF14 32 A 5 N A 3 N S N

Westbrooke LEDGINE (CXF14) Specification Sheet

| | | |
|---------------|--------------|--------------------|
| Project Name: | Location: | MFG: Philips Hadco |
| Fixture Type: | Catalog No.: | Qty: |

Specifications

APPLICATIONS:

The CXF14 is the perfect LED solution for decorative street lighting and is the ideal luminaire for both new and retrofit installations. Other application locations include: residential streets, city streets, campuses and parking lots. The performance, energy savings, and uniformity of this luminaire make it an ideal pendant LED solution.

CONSTRUCTION:

Containing no mercury or other hazardous chemicals, the CXF14 is fully recyclable. The housing is constructed of low copper die-cast aluminum and 0.090" thick spun aluminum. The hinged lens frame is cast aluminum with a stainless steel spring latch for tool-less lamp access. All non-ferrous fasteners prevent corrosion and ensure longer life. Mounting options include side arm, top arm and wall mount.

LED SPECIFICATIONS:

Refer to IES files for energy consumption and delivered lumens for each option. Based on in-situ thermal testing and data from Philips Lumileds and Philips Advance, fixture can be expected to reach 65,000 hours (at >L70 lumen maintenance @ 25°C). The Philips LEDGINE uses Philips Lumileds LEDs. Color temperatures available are ANSI Bin 4000KCCT. Four distributions are available including Type 2, 3, 4 and 5.

ELECTRONIC DRIVER:

The driver included in the LEDGINE Pendants is the Philips Advance XITANIUM LED driver. Standard driver offers 0-10V dimming capability and universal voltage input from 120-277VAC or 347-480VAC. 40 LED options are not available with 0-10V dimming or 347-480V. Input frequency is 50-60Hz and all XITANIUM drivers are RoHS compliant. The driver has <3kV surge suppression built in, 10kV is an additional option.

FINISH:

Thermoset polyester powdercoat is electrostatically applied after a five-stage conversion cleaning process and bonded by heat fusion thermosetting. Laboratory tested for superior weatherability and fade resistance in accordance with ASTM B117 specifications. Powdercoat is 3.0 - 6.0 mil thickness. Interior Coating: approximately 2 ft. at base end of shaft is mechanically cleaned and coated with a zinc rich epoxy powder.

CONTROLS:

The Philips Dynadimmer is an option with this fixture. There are 9 standard factory set dimming schedules available. See specification sheet for details. A custom dimming schedule is available by contacting the factory. Wireless dimming options are also available, contact the factory for details.

IP RATING:

IP66: Dust-tight and sealed against direct jets of water. No Ingress of dust. Will withstand 26.4 gallons of water per minute. Water projected in powerful jets shall not enter the enclosure in harmful quantities. The LED optics chamber is IP66 rated.

CERTIFICATIONS:

ETL listed to U.S. safety standards for wet locations. cETL listed to Canadian safety standards for wet locations. UL8750 and UL1598 compliant. Vibration tested to ANSI C136.31 for Normal Applications. Manufactured to ISO 9001:2008 Standards.

WARRANTY:

5 year extended warranty

OPTIONS:

Optional integral surge suppression device tested in accordance with ANSI/IEEE C62.45 per ANSI/IEEE C62.41.2 Scenario I Category C High Exposure 10kV/10kA waveforms for Line-Ground, Line-Neutral and Neutral-Ground. Enclosure for surge suppression device is constructed of high temperature, flameproof material with an 85°C maximum surface temperature rating. The device consists of a thermally protected transient overvoltage circuit and is designed for use with universal voltage ballasts and drivers.

Width:

21" (diameter)

Height :

22 5/16"

EPA:

1.6 sq ft

Max. Weight:

38 lbs

Westbrooke LEDGINE (CXF14) Specification Sheet

| | | |
|---------------|--------------|--------------------|
| Project Name: | Location: | MFG: Philips Hadco |
| Fixture Type: | Catalog No.: | Qty: |

Ordering Guide

Example: CXF14 32 A 2 N A 3 N S F

| Product Code | CXF14 | Westbrooke LEDGINE |
|--------------------------|-------------------------|------------------------|
| LED BOARDS | 32 | 32 LED'S *1 |
| | 48 | 48 LED'S |
| | 64 | 64 LED'S |
| | 80 | 80 LED'S |
| Finish | A | Black |
| | B | White |
| | G | Verde |
| | H | Bronze |
| | I | Gray |
| | J | Green |
| Optics | 2 | Type II |
| | 3 | Type III |
| | 4 | Type IV |
| | 5 | Type V |
| Color Temperature | N | 4000K |
| Voltage | A | 120-277 VAC |
| | B | 347-480 VAC |
| Drive Current | 3 | 350 mA |
| Dimming Control | N | None |
| | DA | 4 Hrs 25% Reduction |
| | DB | 4 Hrs 50% Reduction |
| | DC | 4 Hrs 75% Reduction |
| | DD | 6 Hrs 25% Reduction |
| | DE | 6 Hrs 50% Reduction |
| | DF | 6 Hrs 75% Reduction |
| | DG | 8 Hrs 25% Reduction |
| | DH | 8 Hrs 50% Reduction |
| | DJ | 8 Hrs 75% Reduction |
| DZ | Custom Dimming Schedule | |
| Surge Suppression | S | Standard Built In <3kV |
| | A | Additional 10kV/10kA |
| Options | F | Fluted Spinning |
| | N | None |

*1 Can not use B Voltage (347-480VAC) and can not use Dimming (DA-DZ) options with the 32LED board option.

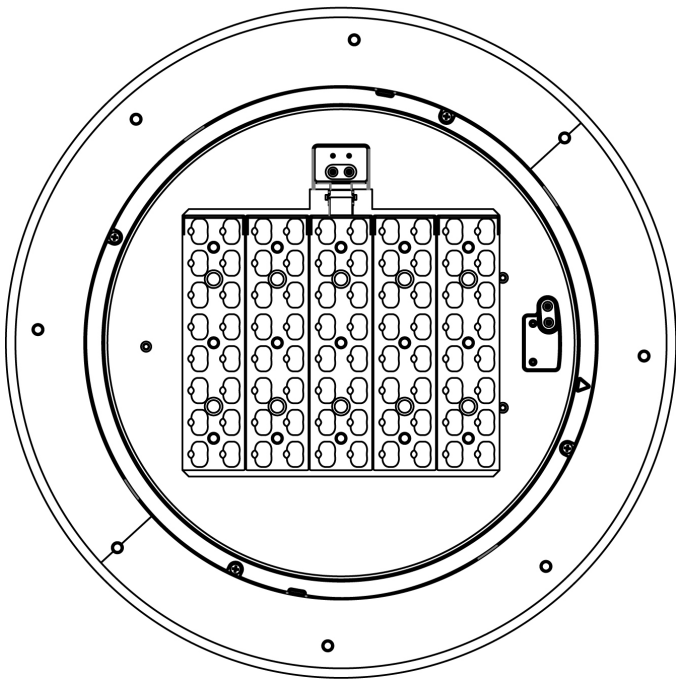
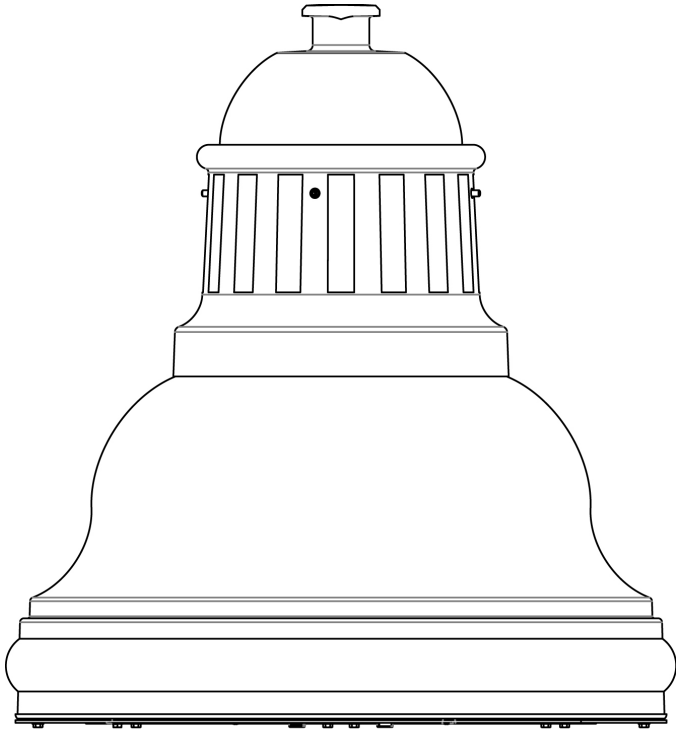

AFCU Cedar Hills
TYPE 'P6' (12' height w/ 2' arm)
#CXF14 32 A 4 N A 3 N S N

Westbrooke LEDGINE (CXF14) Specification Sheet

| | | |
|---------------|--------------|--------------------|
| Project Name: | Location: | MFG: Philips Hadco |
| Fixture Type: | Catalog No.: | Qty: |

Specifications

APPLICATIONS:

The CXF14 is the perfect LED solution for decorative street lighting and is the ideal luminaire for both new and retrofit installations. Other application locations include: residential streets, city streets, campuses and parking lots. The performance, energy savings, and uniformity of this luminaire make it an ideal pendant LED solution.

CONSTRUCTION:

Containing no mercury or other hazardous chemicals, the CXF14 is fully recyclable. The housing is constructed of low copper die-cast aluminum and 0.090" thick spun aluminum. The hinged lens frame is cast aluminum with a stainless steel spring latch for tool-less lamp access. All non-ferrous fasteners prevent corrosion and ensure longer life. Mounting options include side arm, top arm and wall mount.

LED SPECIFICATIONS:

Refer to IES files for energy consumption and delivered lumens for each option. Based on in-situ thermal testing and data from Philips Lumileds and Philips Advance, fixture can be expected to reach 65,000 hours (at >L70 lumen maintenance @ 25°C). The Philips LEDGINE uses Philips Lumileds LEDs. Color temperatures available are ANSI Bin 4000KCCT. Four distributions are available including Type 2, 3, 4 and 5.

ELECTRONIC DRIVER:

The driver included in the LEDGINE Pendants is the Philips Advance XITANIUM LED driver. Standard driver offers 0-10V dimming capability and universal voltage input from 120-277VAC or 347-480VAC. 40 LED options are not available with 0-10V dimming or 347-480V. Input frequency is 50-60Hz and all XITANIUM drivers are RoHS compliant. The driver has <3kV surge suppression built in, 10kV is an additional option.

FINISH:

Thermoset polyester powdercoat is electrostatically applied after a five-stage conversion cleaning process and bonded by heat fusion thermosetting. Laboratory tested for superior weatherability and fade resistance in accordance with ASTM B117 specifications. Powdercoat is 3.0 - 6.0 mil thickness. Interior Coating: approximately 2 ft. at base end of shaft is mechanically cleaned and coated with a zinc rich epoxy powder.

CONTROLS:

The Philips Dynadimmer is an option with this fixture. There are 9 standard factory set dimming schedules available. See specification sheet for details. A custom dimming schedule is available by contacting the factory. Wireless dimming options are also available, contact the factory for details.

IP RATING:

IP66: Dust-tight and sealed against direct jets of water. No Ingress of dust. Will withstand 26.4 gallons of water per minute. Water projected in powerful jets shall not enter the enclosure in harmful quantities. The LED optics chamber is IP66 rated.

CERTIFICATIONS:

ETL listed to U.S. safety standards for wet locations. cETL listed to Canadian safety standards for wet locations. UL8750 and UL1598 compliant. Vibration tested to ANSI C136.31 for Normal Applications. Manufactured to ISO 9001:2008 Standards.

WARRANTY:

5 year extended warranty

OPTIONS:

Optional integral surge suppression device tested in accordance with ANSI/IEEE C62.45 per ANSI/IEEE C62.41.2 Scenario I Category C High Exposure 10kV/10kA waveforms for Line-Ground, Line-Neutral and Neutral-Ground. Enclosure for surge suppression device is constructed of high temperature, flameproof material with an 85°C maximum surface temperature rating. The device consists of a thermally protected transient overvoltage circuit and is designed for use with universal voltage ballasts and drivers.

Width:

21" (diameter)

Height :

22 5/16"

EPA:

1.6 sq ft

Max. Weight:

38 lbs

TYPE UPI

IP68 1.5M



An Acuity Brands Company

M9810

MODULAR IN-GRADE LUMINAIRE

MONOCHROMATIC LED SINGLE LENS

DESCRIPTION

The M9810 Modular In-grade lights are multi-purpose units designed for flush mounting in soil or concrete. The M9800's are used to uplight large architectural and landscape features. The units consist of a factory sealed lamp module placed in a secured Rough-In Section (RIS) which includes channeled convective cooling, an integral junction box, and door assembly.

FEATURES & SPECIFICATIONS

DOOR MATERIAL: Cast aluminum, cast bronze, round. Two stainless steel captive fasteners lock the Lamp Module into the Rough-In Section.

ROUGH-IN SECTION: Injection molded polymer cylinder with integral junction box for branch wiring (410 ccm - 25 in³), U.V. stabilized, impact and corrosion resistant for use in many environments. Houses Power Module, Lamp Modules and finishing components.

LAMP MODULE: Stainless steel, sealed and purged of all moisture with silicone rubber gasket, stainless steel clamp band and single fastener. Electrical connection to Lamp Module is done through submersible connector with gold-plated contacts. **(LED Array Included)**

LAMP TYPE: LED: Monochromatic LEDs, 84 Input Watts. Lumen maintenance of individual light sources has been independently tested using IESNA LM80 standards.

VOLTAGE: MVOLT (120-277)

DISTRIBUTION: See Ordering Guide

FINISHING SECTION: Single lens design includes door assembly with 360° Roto-Lock™ lamp module support ring. Module indexing provides easy maintenance and relamping without re-aiming. Active optical lenses are also available. Door trim locks into position with two stainless steel captive, tamper-resistant fasteners.

POWER MODULE: LED driver is encapsulated in a custom-heat dissipating epoxy resin to eliminate all moisture intrusion to the ballast. Provided with submersible rated cord/connector for connection to integral junction box and lamp module.

CONDUIT ENTRIES/JUNCTION BOX: Two 3/4" NPT bottom openings, standard. Box suitable for through branch wiring. J-Box volume 25 in³.

ACCESSORIES: Internal Glare Control, Rock Guards, Glare Shields are available.

LISTINGS: CSA, CSA_{US}

WARRANTY: Limited 5 year warranty for LED components (see Hydrel Terms & Conditions for details)

| | |
|------|----------|
| TYPE | JOB NAME |
|------|----------|

| PART NUMBER | | | | | | |
|-----------------|-------------|-----------|---------|--------------|---------|--|
| Model | Material | Lamp Type | Voltage | Distribution | Lens | |
| Conduit Entries | Accessories | Options | Lamp | Finish | Listing | |

Bronze or Aluminum Round

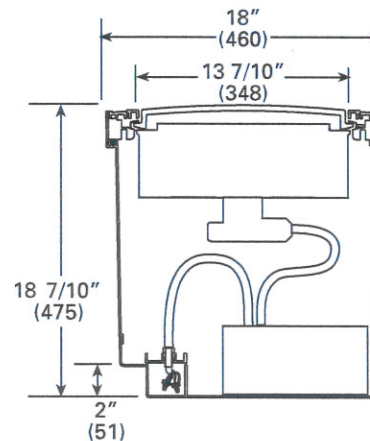
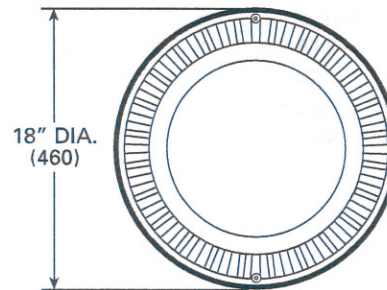
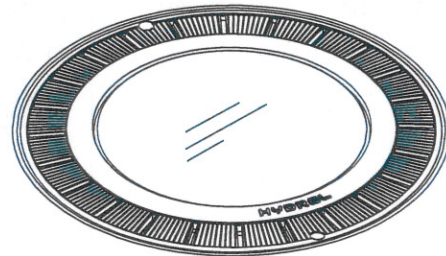

| |
|-----------|
| APPROVALS |
|-----------|

M9810 ORDERING INFORMATION

50/60 Hz Application

Choose the boldface catalog nomenclature that best suits your needs.

PART NO.
M9810 B LED WHT41K MVOLT SP FLC10 34B RG LP BZ

EXAMPLE:

| | | | | | | | | | | | |
|--|---|--|--|---|---|---|------------|------------|-----------|-----------|------------|
| M9810 | A | LED | WHT53K | MVOLT | SP | FLC | 34B | IHL | LP | BZ | IEC |
| Model | Lamp Type | Voltage | Lens | Accessories | Lamp | Listing | | | | | |
| <input type="checkbox"/> M9810 Round Single Lens | <input type="checkbox"/> LED | <input type="checkbox"/> MVOLT | <input type="checkbox"/> FLC¹ Flat Lens Clear <input type="checkbox"/> FLC5 5°Axial Spread <input type="checkbox"/> FLC10 10°Tilt <input type="checkbox"/> FLC20 20°Tilt | Internal <input type="checkbox"/> IHL Internal Honeycomb Louver External³ <input type="checkbox"/> GS Glare Shield <input type="checkbox"/> RG Rock guard Trims Rings <input type="checkbox"/> BTR Bronze trim ring | <input type="checkbox"/> LP Lamp Installed | <input type="checkbox"/> IEC International Electro- technical Commission. For European format only. | | | | | |
| Material | LED Color | Distributions | Conduit Entries | Options | Finish⁴ | | | | | | |
| <input type="checkbox"/> A Aluminum <input type="checkbox"/> B Bronze | <input type="checkbox"/> WHT30K White <input type="checkbox"/> WHT41K White <input type="checkbox"/> WHT53K White <input type="checkbox"/> RED Red <input type="checkbox"/> GRN Green <input type="checkbox"/> BLU Blue <input type="checkbox"/> AMB Amber | <input type="checkbox"/> SP Spot <input type="checkbox"/> MFL Medium Flood <input type="checkbox"/> WFL Wide Flood <input type="checkbox"/> LSD Linear Spread Distribution | <input type="checkbox"/> 20B⁵ M20 Bottom <input type="checkbox"/> 25B⁵ M20 Bottom <input type="checkbox"/> 34B² 3/4"NPT bottom | <input type="checkbox"/> LDIM 0-10 Volt LED Dimming | <input type="checkbox"/> BL Black <input type="checkbox"/> BZ Bronze <input type="checkbox"/> DDB Dark Bronze <input type="checkbox"/> DNA Natural Alum. <input type="checkbox"/> GN Green <input type="checkbox"/> GR Gray <input type="checkbox"/> SND Sand <input type="checkbox"/> STG Steel Gray <input type="checkbox"/> TVG Terra Verde Green <input type="checkbox"/> WH White <input type="checkbox"/> CF Custom Finish | | | | | | |

Notes:

- ¹ FLC is the default lens if no option is chosen.
- ² 34B is the default conduit if no option is chosen.
- ³ Options are mutually exclusive, choose only one.
- ⁴ Finish only available on "A" door material.
- ⁵ For use with IEC only.